

Type List 1-2016

Valid from 01.01.2016



DENVER

 nolte®
DELBRÜCK

■ Modern exklusive design

- Wardrobes:**
- Wardrobe height: 222 cm
 - Wardrobe depths: 44 cm and 62 cm
 - Front surface Front 21, 18 mm thick with soft edging
 -  New door length: 220 cm, visible base plinth: 2 cm
 - Style: D01, exterior and interior doors in same surface colour
 - Hinged-door elements available in widths of 50 cm and 100 cm
 - Sliding door robes are available with different accent colours and in a width of 165 cm up to 300 cm
- A full cornice frame with or without lighting is available at a surcharge
- The hinged door robes are furnished with Softclose-doorstop as standard feature
- Made to measure items
- Bed systems:**
- Modern beds in the widths 160 cm, 180 cm and 200 cm
 - The height of the resting area can be adjusted to differend levels
- Bedside lockers:**
- Bedside cabinets with one drawer and a width of 60 cm make the bedset complete
 - The drawers of the bedside cabinet feature standard Quadro ball bearing runners self-closure and Softclose
- Chests / occasional furniture:**
- Chests either with doors or drawers are available in a height of 99 cm and in a width of 120 cm
 - All drawers are fitted with Quadro technology and self-closing feature in conjunction with Softclose.
 - This range is completed by a wall mirror
- carcass colours:**
- | | |
|-------------------------------------|-------------------------------------|
| Exterior: cream matt | interior carcass colour: Life Stone |
| Exterior side: french walnut veneer | interior carcass colour: Life Stone |
| Exterior: royal oak veneer | interior carcass colour: Life Stone |
- Surfaces:**
- Lacquer:
- The lacquers we use have been tested and comply with the DIN standards as well as the stringent provisions of the health ordinance
- Solid wood veneer:
- Use of high-quality, carefully selected veneer
 - Individual appearance because it can be used both vertically and horizontally)
 - Natural growth features as well as differences in colour and structure are typical product properties and an unmistakable sign of genuineness

For constructive reasons and in the context of a technical further development we leave the right up to us to carry out changes in the described model any time.



Contents

Page

<u>Model characteristics</u>	<u>2</u>
<u>Price-sheet for standard bedrooms</u>	<u>4 - 7</u>
<u>Bed, overbed panel</u>	<u>8</u>
<u>Bedside table, chests, mirrors</u>	<u>9</u>
<u>Wardrobes with hinged doors</u>	<u>10</u>
<u>Add-on units with hinged doors</u>	<u>11</u>
<u>Wardrobes with Sliding doors</u>	<u>12</u>
<u>Surcharge for hinged-door wardrobes</u>	<u>13</u>
<u>Energy efficiency grades</u>	<u>14</u>

An overview of the max. permissible loading weight of each element can be found on our website www.nolteD.com under quality and in our assembly instructions!

Minimum order value 400,- €. Order of a lower value will only be delivered together with following orders.
Thanks for your kind understanding.

carcass colour	surface colour:	Front surface	Style:	Price Group:
Cream matt	Cream lacquer	Front 21	D01	PG 1
French walnut veneer Royal oak veneer	Cream lacquer	Front 21	D01	PG 2

 Please mention the carcass surface colour, as well as the contrast colours of the bedset and the bedside cabinets with your order !

KPZ1190 complete arrangements with different wardrobe designs

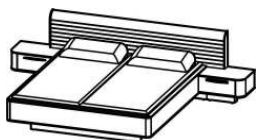
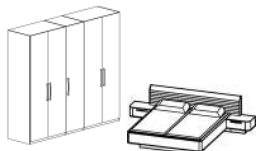
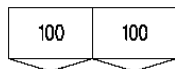
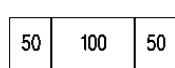
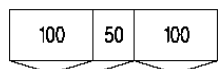
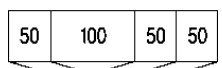
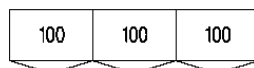
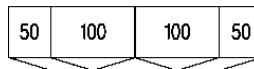
Price bedset	Order Code	PG 1		PG 2					
		EURO	EURO	EURO	EURO				
Bed B1190 in cream matt with french walnut- or royal oak veneer accents, overbed panel PA1190, 2 pending bedside cabinets NS1190 with 1 drawer each 	KPZ1190								
Surcharges: cornice frame PT21 or cornice frame PTB21 with LED-light in french walnut- or royal oak veneer For details please refer to page 13									
<table border="1"> <thead> <tr> <th>O. Code</th> <th>EURO</th> </tr> </thead> <tbody> <tr> <td></td> <td></td> </tr> </tbody> </table>						O. Code	EURO		
O. Code	EURO								
price for bedset including wardrobe									
	4-door-wardrobes, 200 cm								
		KPZ1190 D200	H222		PT21 200 PTB21 200				
price for bedset including hinged door robe	4-door-wardrobes, 200 cm								
		KPZ1190 D201	H222		PT21 200 PTB21 200				
	5-door-wardrobes, 250 cm								
		KPZ1190 D250	H222		PT21 250 PTB21 250				
	5-door-wardrobes, 250 cm								
		KPZ1190 D251	H222		PT21 250 PTB21 250				
	6-door-wardrobes, 300 cm								
		KPZ1190 D300	H222		PT21 300 PTB21 300				
	6-door-wardrobes, 300 cm								
		KPZ1190 D301	H222		PT21 300 PTB21 300				

For optional accessories, please see following pages

Mirror SP



Lighting for headboard LA19



indirect lighting for bedside panels and footboard LA1190







Spotlights AST 32 / 33



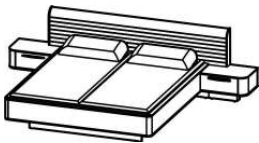
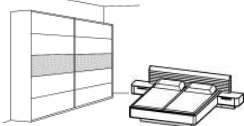
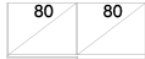



carcass colour	surface colour:	Contrast	Style:	Price Group:
Cream matt	Cream lacquer	French walnut veneer Royal oak veneer	S72	PG 1
French walnut veneer Royal oak veneer	Cream lacquer	French walnut veneer Royal oak veneer	S72	PG 2

 Please mention the surface of the carcass, as well as the accent colour for the sliding door robe, the bedset and the bedside cabinets with your order !

KPZ1190 complete arrangements with different wardrobe designs			PG 1	PG 2
Price bedset	Order Code		EURO	EURO
Bed B1190 in cream matt with french walnut- or royal oak veneer accents, overbed panel PA1190, 2 pending bedside cabinets NS1190 with 1 drawer each 	KPZ1190			
			Surcharges: Cornice frame PT40 in french walnut- or royal oak veneer For details please refer to page 13	
			O. Code	EURO
price for bedset including wardrobe				
 price for bedset including sliding door robe Design S72	with 2-door-wardrobes, 165 cm 	KPZ1190 STS165	H222	PT40 165
	2-door, 200 cm 	KPZ1190 STS200	H222	PT40 200
	2-door-wardrobes, 245 cm 	KPZ1190 STS246	H222	PT40 245
	2-door-wardrobes, 300 cm 	KPZ1190 STS301	H222	PT40 300

For optional accessories, please see following pages

Mirror SPS 	Lighting for headboard LA19 	indirect lighting for bedside panels and footboard LA1190 	Spotlights AST 32 / 33 	Spotlights AST 110 
--	--	--	--	---

Energy efficiency grades please refer to page 14
 customizations and accessories, see separate pricelist



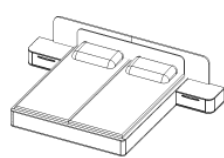
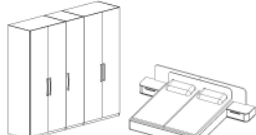
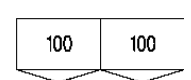
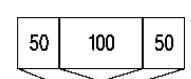
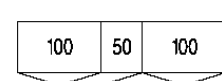
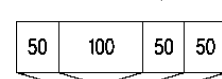
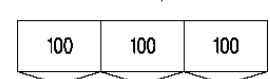
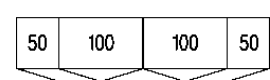

carcass colour	surface colour:	Front surface	Style:	Price Group:
Cream matt	Cream lacquer	Front 21	D01	PG 1
French walnut veneer Royal oak veneer	Cream lacquer	Front 21	D01	PG 2

 Please mention the carcass surface colour, as well as the contrast colours of the bedset and the bedside cabinets with your order !

KPZ1191 complete arrangements with different wardrobe designs

Price bedset	Order Code	PG 1		PG 2	
		EURO	EURO	EURO	EURO
Bed B1190 in cream matt with french walnut- or royal oak veneer accents, overbed panel PA1191, 2 pending bedside cabinets NS1190 with 1 drawer each 	KPZ1191				
Surcharges: cornice frame PT21 or cornice frame PTB21 with LED-light in french walnut- or royal oak veneer For details please refer to page 13					
		O. Code	EURO		
price for bedset including wardrobe					
 price for bedset including hinged door robe	4-door-wardrobes, 200 cm 	KPZ1191 D200	H222		PT21 200 PTB21 200
	4-door-wardrobes, 200 cm 	KPZ1191 D201	H222		PT21 200 PTB21 200
	5-door-wardrobes, 250 cm 	KPZ1191 D250	H222		PT21 250 PTB21 250
	5-door-wardrobes, 250 cm 	KPZ1191 D251	H222		PT21 250 PTB21 250
	6-door-wardrobes, 300 cm 	KPZ1191 D300	H222		PT21 300 PTB21 300
	6-door-wardrobes, 300 cm 	KPZ1191 D301	H222		PT21 300 PTB21 300



For optional accessories, please see following pages

Mirror SP 	Lighting for headboard LA19 	indirect lighting for bedside panels and footboard LA1190 	Spotlights AST 32 / 33 	indirect lights for overbed panel LA1191 
--	---	---	---	--





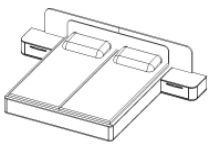
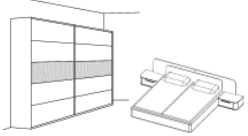
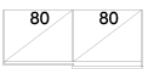
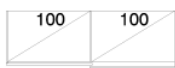
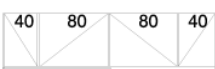

Energy efficiency grades please refer to page 14
 customizations and accessories, see separate pricelist

carcass colour	surface colour:	Contrast	Style:	Price Group:
Cream matt	Cream lacquer	French walnut veneer Royal oak veneer	S72	PG 1
French walnut veneer Royal oak veneer	Cream lacquer	French walnut veneer Royal oak veneer	S72	PG 2

 Please mention the surface of the carcass, as well as the accent colour for the sliding door robe, the bedset and the bedside cabinets with your order !

KPZ1191 complete arrangements with different wardrobe designs			PG 1	PG 2
Price bedset	Order Code		EURO	EURO
Bed B1190 in cream matt with french walnut- or royal oak veneer accents, overbed panel PA1191, 2 pending bedside cabinets NS1190 with 1 drawer each 	KPZ1191			
			Surcharges: Cornice frame PT40 in french walnut- or royal oak veneer For details please refer to page 13	
			O. Code	EURO
price for bedset including wardrobe				
 price for bedset including sliding door robe Design S72	with 2-door-wardrobes, 165 cm	KPZ1191 STS165	H222	PT40 165
				
	2-door, 200 cm	KPZ1191 STS200	H222	PT40 200
				
	2-door-wardrobes, 245 cm	KPZ1191 STS246	H222	PT40 245
				
	2-door-wardrobes, 300 cm	KPZ1191 STS301	H222	PT40 300
				

For optional accessories, please see following pages



Mirror SPS 	Lighting for headboard LA19 	indirect lighting for bedside panels and footboard LA1190 	Spotlights AST 32 / 33 	Spotlights AST 110 	indirect lights for overbed panel LA1191 
---	---	---	---	--	--

Energy efficiency grades please refer to page 14
 customizations and accessories, see separate pricelist

Finish:	Price Group:
cream matt with french walnut veneer Cream matt in combination with royal oak veneer	PG 1

 Please mention the design of the bedset with your order !

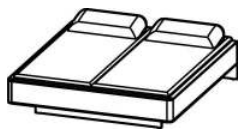
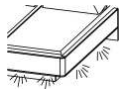
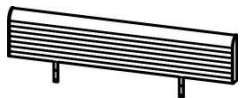
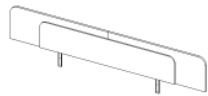



 Resting area can be adjusted to different levels
All beds also available in 190 cm length at the same price. Please state bed length!
Extended bed length and shortened bed length, see separate pricelist Customizations !

Model description	W:	H:	D:	Order Code	Mattress size	PG 1
						EURO
 <p>compact bed Bedside height: 45 cm Footboard height: 45 cm</p>	211 191 171	45 45 45	207 /197 207 /197 207 /197	B1190 B1190 B1190	200x200 /190 180x200 /190 160x200 /190	
 <p>indirect lighting for bedside panels and footboard switchable by radio switch set</p>				LA1190		
 <p>Upholstered headboard panel with artificial leather in cream colour for bed B1190 side covers in french walnut- or royal oak veneer Total depth including bed B1190 216 / 206 cm</p>	253 233 213	47 47 47	11 11 11	PA1190 PA1190 PA1190		
 <p>overbed panel in royal oak or french walnut veneer with accent colour cream lacquer for bed B1190 Total depth including bed B1190 211 / 201 cm</p>	280 260 240	45 45 45	6 6 6	PA1191 PA1191 PA1191		
 <p>indirect lights for overbed panel PA1191 manually switchable with dimmer-function</p>				LA1191		
 <p>Lighting for headboard (2 pieces) Design: chrome coloured</p>				LA19		
<p>Extended bed length 210 / 220 cm Shortened bed length (state size!)</p>				BSÜ BSK		

carcass colour	surface colour:	Surface of base- and top panel	Price Group:
Cream matt Cream matt	Cream lacquer Cream lacquer	French walnut veneer Royal oak veneer	PG 1

 Please mention colour of the bases and top panels with your order!

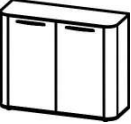
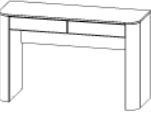
All drawers feature standard Quadro ball bearing runners, self-closure and SoftClose version.

All drawers feature standard Quadro ball bearing runners, self-closure and SoftClose version.					PG 1	
Type	Model description	W:	H:	D:	Order Code	EURO
	Pending bedside cabinet with one drawer (height 24 cm) (please mention left or right)	60 60	44 44	42 42	NS1190 /R NS1190 /L	
	Drawer chest with 5 drawers	120	99	42	K1193	
	Cabinet double-door, with 2 shelves	120	99	42	K1196	
	Dressing table with 2 drawers	120	75	42	FSP1190	
	Wall mirror in carcass colour (can be hung up also horizontal)	57	99	4	SP 32	
	Wall-mounted shelf in carcass colour with 2 wall fixings	48	3	20	WBO50	
	Wall-mounted shelf in carcass colour with 2 wall fixings	99	3	20	WBO100	

Wardrobes with hinged doors

DENVER

2 interior shelves and 1 clothes rail and SoftClose doorstop, (44cm deep units without rail)

carcass colour	surface colour:	Front surface	Style:	Price Group:
Cream matt	Cream lacquer	Front 21	D01	PG 1
French walnut veneer Royal oak veneer	Cream lacquer	Front 21	D01	PG 2

 Please mention the carcass surface colour with your order !

Handle design

 G 164 chrome coloured
(per door one handle)



Style:

D01



Height:: 222 cm

Wardrobe height including cornice frame = height + 3 cm

Wardrobe width including cornice frame = width + 8 cm

Surcharges:
cornice frame PT21
or
cornice frame PTB21
with LED-light
in french walnut- or
royal oak veneer
For details please refer
to page 13

Depth 62 cm and 44 cm at same price! Please indicate depth!

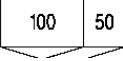
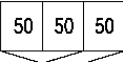
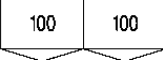
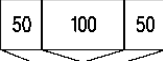
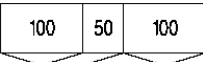
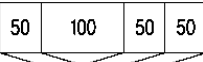
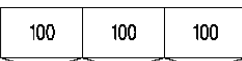
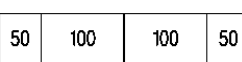
Width Layout 150 - 300 cm	Order Code		PG 1	PG 2	Order Code	EURO
	EURO	EURO	EURO	EURO		
151 cm 	D 150	H222			PT21 150 PTB21 150	
151 cm 	D 151	H222			PT21 150 PTB21 150	
200 cm 	D 200	H222			PT21 200 PTB21 200	
200 cm 	D 201	H222			PT21 200 PTB21 200	
250 cm 	D 250	H222			PT21 250 PTB21 250	
250 cm 	D 251	H222			PT21 250 PTB21 250	
300 cm 	D 300	H222			PT21 300 PTB21 300	
300 cm 	D 301	H222			PT21 300 PTB21 300	

For supplements of hinged-door elements, please see page 10

For surcharges, please see page 11

Energy efficiency grades please refer to page 14

customizations and accessories, see separate pricelist

Add-on units with hinged doors

DENVER

Each element has 2 shelves and 1 clothes rail, incl. mid- or endpanels and softclose-doorstop,(44 cm deep units without rail)

carcass colour	surface colour:	Front surface	Price Group:
Cream matt	Cream lacquer	Front 21	PG 1
French walnut veneer Royal oak veneer	Cream lacquer	Front 21	PG 2

The elements can be used individually or as part of customised wardrobes.
Plan your wardrobe design from the left to the right,the mid- and end panels will be added automatically.

Depth 62 cm and 44 cm at same price! Please indicate depth!

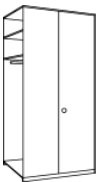
Type	Width	Model description	Order Code		PG 1	PG 2
					EURO	EURO
	50	single-door (please indicate left or right hinged door)	DE 50	H222		
	100	double-door	DE 100	H222		

For surcharges, please see page 11
customizations and accessories, see separate pricelist

Wardrobes with Sliding doors

DENVER

Each element including 2 shelves, 1 clothes rail and softclose-doorstop

carcass colour	surface colour:	Contrast	Style:	Price Group:
Cream matt	Cream lacquer	French walnut veneer Royal oak veneer	S72	PG 1
French walnut veneer Royal oak veneer	Cream lacquer	French walnut veneer Royal oak veneer	S72	PG 2

 Please mention the carcass- and the accent colour with your order!

Description of the diagram



front view colour accents

View in lacquer

Design S72

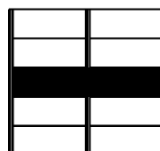

Height: 222 cm

Depth: 72 cm

Interior wardrobe depth: 62 cm

Wardrobe height including cornice frame = height + 5 cm





Wardrobe width including cornice frame PT40 = width + 10 cm

Surcharges:



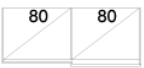

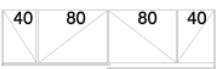
Cornice frame PT40

in french walnut- or



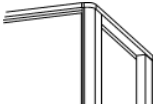
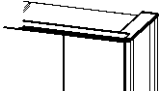

royal oak veneer

Width	Layout 200 - 300 cm	Order Code		PG 1	PG 2	O. Code	EURO
				EURO	EURO		
165 cm		STS 165	H222			PT40 165	
200 cm		STS 200	H222			PT40 200	
245 cm		STS 246	H222			PT40 245	
300 cm		STS 301	H222			PT40 300	

For surcharges, please see page 13
customizations and accessories, see separate pricelist

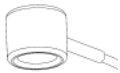
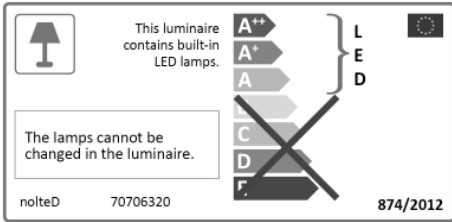
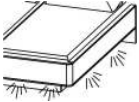
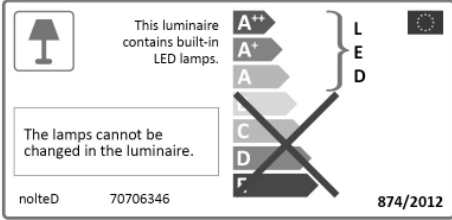
Type	Order Code	EURO
Mirror		
 <p>surcharge hinged door with crystal mirror with vertical facet (please mention left and right)</p>	SP 50 L/R	
 <p>Surcharge: set of crystal mirrors for sliding door robes, for left and right hand sliding door (2 pieces)</p> <p>Please indicate number and position of elements with mirror !</p>	SPS	
Cornice frame in carcass colour		
 <p>1 set lateral pieces of cornice frame with plastic profile without lighting in french walnut- or royal oak veneer width of wardrobe incl. cornice frame + 8 cm</p>	PTS 21	
 <p>top piece of cornice frame with plastic profile without lighting in french walnut- or royal oak veneer height of wardrobe incl. cornice frame + 3 cm Price per door</p> <p>infill-panels longer than 300 cm will be cut in the middle</p>	PTKS 21	
Spotlights with LED-light, switchable by remote control		
 <p>Surface mounted spotlights incl. Transformer Design: chrome coloured</p> <p>Power per emitter: 2,9 W H: 7 cm W: 32 cm</p>	<p>2 pieces 3 pieces</p>	<p>AST 32 AST 33</p>
 <p>Surface mounted spotlights incl. Transformer Design: chrome coloured max. 3 spots per combination</p> <p>Power per emitter: 14,0 W H: 7 cm W: 150 cm</p>	1 piece	AST 110

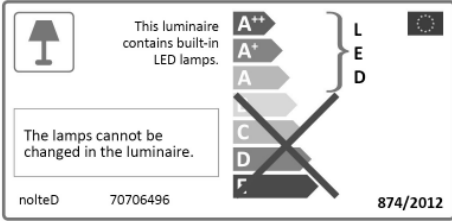
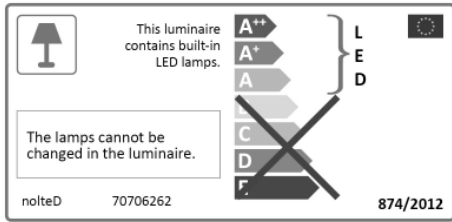
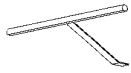
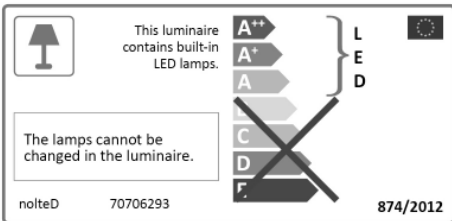
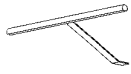
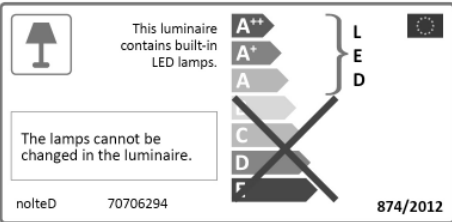
Energy efficiency grades

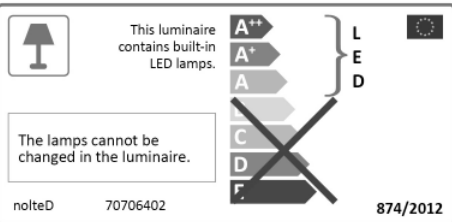
Type	article description	
	Lighting for headboard LA 19 Design: chrome coloured	 <p>This luminaire contains built-in LED lamps.</p> <p>The lamps cannot be changed in the luminaire.</p> <p>nolteD 70706320 874/2012</p>
	indirect lighting for bedside panels and footboard LA 1190	 <p>This luminaire contains built-in LED lamps.</p> <p>The lamps cannot be changed in the luminaire.</p> <p>nolteD 70706346 874/2012</p>
	indirect lights for overbed panel LA 1191	 <p>This luminaire contains built-in LED lamps.</p> <p>The lamps cannot be changed in the luminaire.</p> <p>nolteD 70706496 874/2012</p>
	cornice frame PTB21 with LED illumination PTB21	 <p>This luminaire contains built-in LED lamps.</p> <p>The lamps cannot be changed in the luminaire.</p> <p>nolteD 70706262 874/2012</p>
	Spotlights AST 32 Design: chrome coloured	 <p>This luminaire contains built-in LED lamps.</p> <p>The lamps cannot be changed in the luminaire.</p> <p>nolteD 70706293 874/2012</p>
	Spotlights AST 33 Design: chrome coloured	 <p>This luminaire contains built-in LED lamps.</p> <p>The lamps cannot be changed in the luminaire.</p> <p>nolteD 70706294 874/2012</p>
	Spotlights AST 110 Design: chrome coloured	 <p>This luminaire contains built-in LED lamps.</p> <p>The lamps cannot be changed in the luminaire.</p> <p>nolteD 70706402 874/2012</p>

Nolte-Möbel GmbH & Co. KG
Westenholzer Straße 61
D-33129 Delbrück
Tel. +49 5250 989-0
Fax +49 5250 989-199
info@nolteD.com
www.nolteD.com

